

OVERCURRENT FAULT DETECTION USING ACS37610 CORELESS CURRENT SENSOR

By Loic Messier
Allegro MicroSystems France

INTRODUCTION

In many industrial and automotive current sensing applications (Battery charging and monitoring, DC/DC converter, motor control, inverter, etc.), it is not only important to measure the current accurately but also to protect the system and circuit against overcurrent surge.

This application note explains how the Overcurrent-Fault (OCF) feature of Allegro ACS37610 device can be used in application to reliably detect overcurrent conditions and how it can be configured to optimize accuracy and cover different application needs.

DEFINITIONS

Overcurrent

An overcurrent is defined as a current level which exceeds a specified nominal range, generally following short-circuit or overload conditions. Because exceeding the nominal current for which a system is defined can damage electrical components and circuits, it is important for a system to detect such event as quickly as possible and react accordingly (reducing or limiting power, opening the circuit, etc.).

ACS37610 Coreless Current Sensor

Allegro ACS37610 device is a Hall-based differential sensor in a TSSOP8 package made for current sensing applications where no core or shield is required. It provides an analog output proportional to the differential field sensed, induced by current flow on an electric conductor (Figure 1).

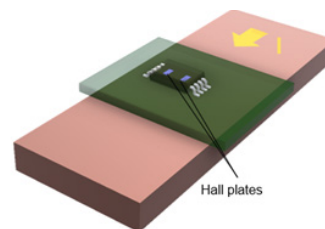

Figure 1: Coreless current sensing

For more details on coreless sensing principle see product datasheet and application notes on Allegro Website : <https://www.allegromicro.com/>

In addition to its analog output, the ACS37610 device provides Fault information using a dedicated digital output (high/low state). The FAULT output can be configured to trigger on overcurrent and overtemperature conditions, with FAULT signal defined as an "Active Low" digital signal. See FAULT circuit figure 2.

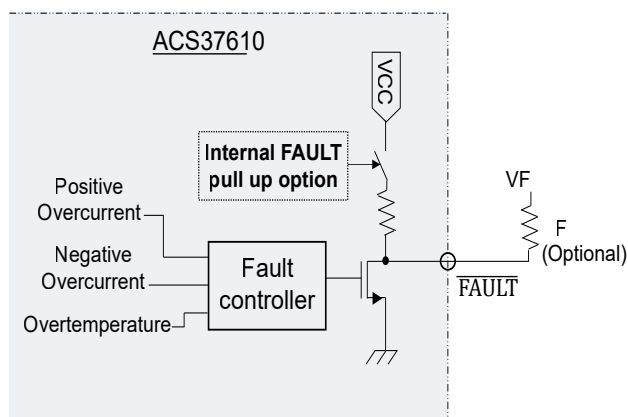

Figure 2: FAULT output circuit

Figure 3 shows operational principle; device analog output (proportional to the current flowing through the conductor) and FAULT pin response to overcurrent condition (from pre-defined threshold).

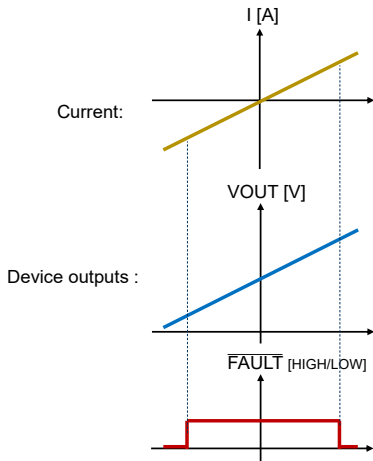

Figure 3: ACS37610 Outputs

Analog Output Range

The ACS37610 device is available in both Bidirectional output mode for measuring current in positive and negative directions, and Unidirectional output mode to measure current in only one direction (e.g DC applications).

When no current flows in the conductor, no differential field is sensed, the analog output is equal to the Quiescent Output Voltage value (QVO), $V_{CC}/2$ in the case of the bidirectional version and $V_{CC}/10$ in the case of the unidirectional version. When current flows, differential field is sensed, the analog output can swing from its low saturation (VSAT[Low]) to its high saturation voltage (VSAT[High]), with a normal operating range referred to as the full-scale range, and equal to 80% of the device supply voltage (4 V swing with 5 V VCC).

As seen in Figures 4 and 5, the output range can be separated in three segments: the full-scale range (1) usually defined as the measurement range, the extended range (2) and the saturation range (3).

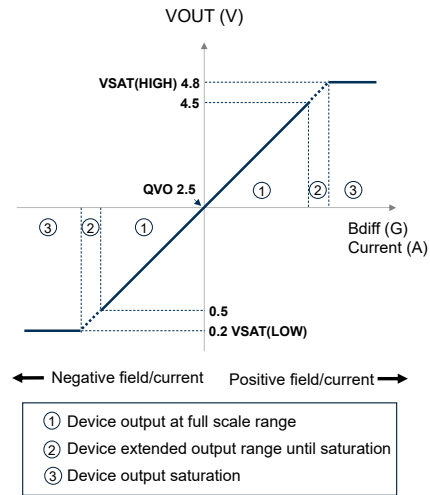

Figure 4: Bidirectional output range at 5 V VCC

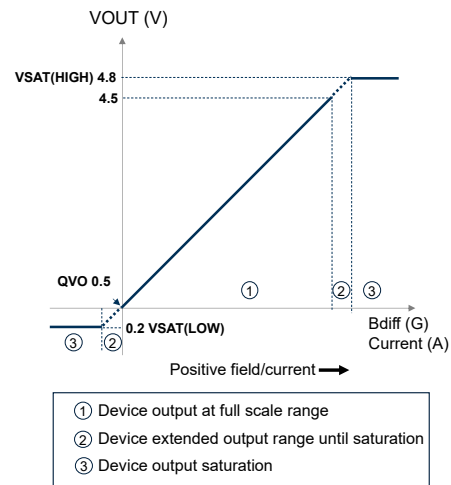

Figure 5: Unidirectional Output Range at 5 V VCC

Device sensitivity is generally adjusted such that the full-scale output corresponds to the measurement range of the application, but while the analog output is limited by the saturation region, the device overcurrent detection can even occur outside the saturation level, allowing user to optimize the measurement range of the system to the operating current while still being able to detect any over current event outside this range.

OVERCURRENT FAULT FEATURE

The device Overcurrent Fault (OCF) feature is fully customer programmable using device integrated memory (EEPROM). The overcurrent threshold can be programmed from 50% to 200% of full-scale output so that detection can occur inside

the measurement range, allowing redundancy of overcurrent information (using V_{OUT} and FAULT outputs) or outside the measurement range, even if the analog output is saturated (losing redundancy in this case).

Figure 6 shows the programmable overcurrent threshold range on a 5 V bidirectional device (in yellow) from 50% to 200% full-scale on positive and negative current/output.

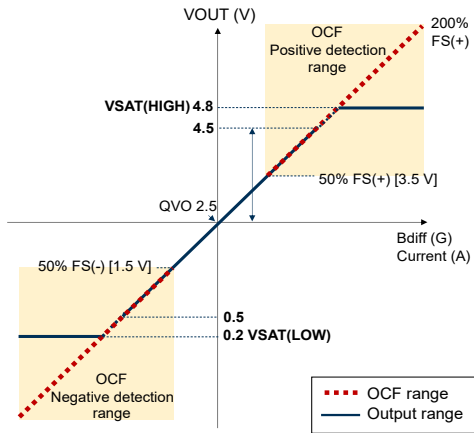

Figure 6: Overcurrent Threshold Range, 5 V Bidirectional

Figure 7 shows the programmable Overcurrent threshold range on a 5 V unidirectional device (in yellow) from 50% to 200% of positive full-scale current/output.

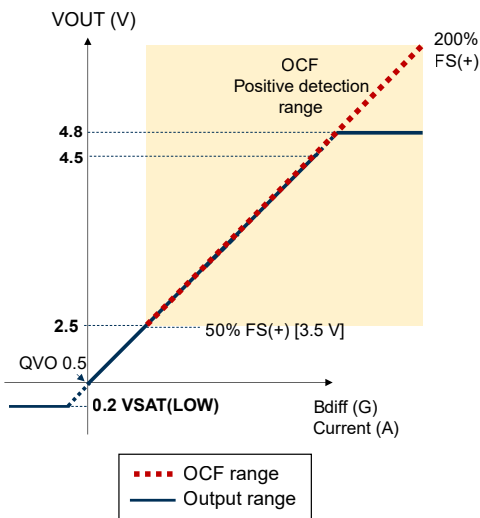

Figure 7: Overcurrent threshold range, 5 V unidirectional

Thanks to the overcurrent detection architecture, the device is capable of tracking the current even when the analog output

is saturated (up to 200% full-scale), allowing to optimize the measurement range to the real operating current and not constrain the full-scale definition to the overcurrent range: this can lead to better system resolution and higher accuracy in the operating current range.

As an example, consider an application with an operating current range of ± 1000 A and an overcurrent range of ± 1500 A; Figure 8 shows the estimated quadratic error in the operating range if the device is configured to have its full-scale at ± 1000 A, compared to having it defined at ± 1500 A to include the overcurrent range.

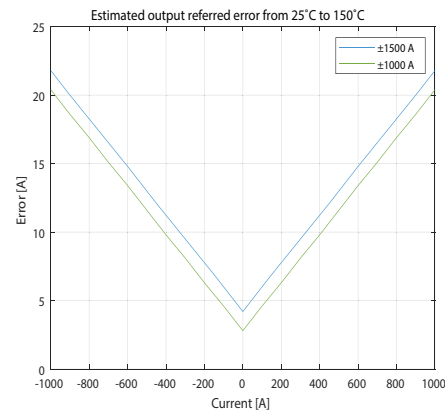

Figure 8: Estimated full-scale error

As seen in this example, the error is clearly reduced when the full-scale output is defined closer to the operating range. To achieve this, the full-scale output would be defined as the operating range (± 1000 A), while the OCF threshold would be programmed to 150% of that full-scale (± 1500 A).

Overcurrent Response Time

Although the ACS37610 device offers a 250 kHz bandwidth, the effective bandwidth of the system may be limited in the application by the sampling rate of the Analog-to-Digital converter (ADC) and microcontroller used to acquire and post process the analog output of the current sensor. This can significantly reduce the overcurrent detection time if relying on the analog output to detect it.

Figure 9 shows a step response on the analog output (V_{OUT}) and corresponding samples based on 500 kS/s (Kilo Sample per second) ADC sampling. This shows how critical the sample rate is to achieve fast overcurrent detection.

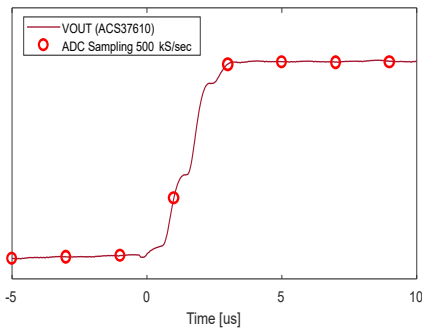

Figure 9: V_{OUT} step response and sampling effect

To limit impact on the step response measured, the sampling rate should be at least twice the bandwidth of the ACS37610 device (Nyquist-Shannon Theorem).

While fast overcurrent detection on the analog output can be achieved with fast ADCs or external comparators, the ACS37610 allows use of a simplified circuit with lower sampling rate while still being able to detect overcurrent event in a few microseconds using its digital FAULT output.

As seen on step response Figure 10 (device analog output, FAULT output and sampled signal assuming 100 kS/s ADC), FAULT output allows detection of Overcurrent within 2.5 μ s while the analog signal is not yet sampled by the ADC.

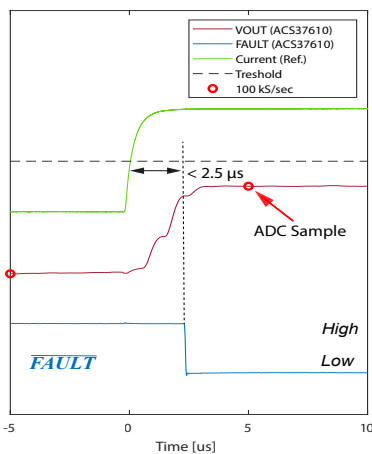

Figure 10: V_{OUT} step response and sampling effect

Overcurrent Fault Hysteresis

To prevent FAULT comparator instability/chatter, the OCF circuit integrates a minimum hysteresis value (corresponding to a typical hysteresis of 11%). The ACS37610 device also allows this hysteresis value to be increased by programming to further prevent FAULT release on noisy signals.

As seen in Figure 11, the FAULT gets randomly released and triggered due to high signal noise when current is around the threshold level, the hysteresis level is set to the minimum “OCF_hyst = 0” (corresponding to a typical hysteresis of 11%).

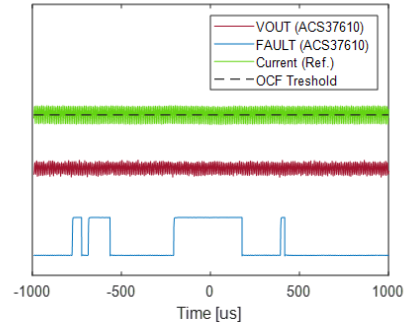

Figure 11: Noisy current signal effect on Overcurrent Fault - OCF_hyst = 0

Figure 12 shows the FAULT behavior under the same conditions when programmed to a higher hysteresis value “OCF_hyst = 1”, (corresponding to a typical hysteresis of 22%). The FAULT is triggered and does not get released on noise.

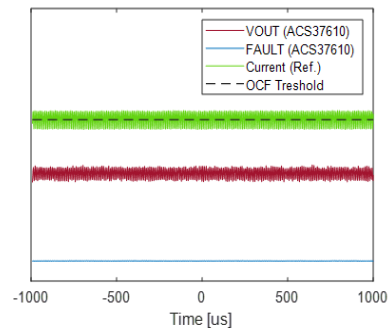

Figure 12: Noisy current signal effect on Overcurrent Fault - OCF_hyst = 1

Another use case for the hysteresis is to guarantee that the current will be reduced to a certain level in order to release the Fault following an overcurrent event, as shown in Figure 13 and Figure 14. In Figure 13 the hysteresis is programmed to the minimum (typical 11%) whereas in Figure 14 the hysteresis is programmed to the maximum (typical 75%).

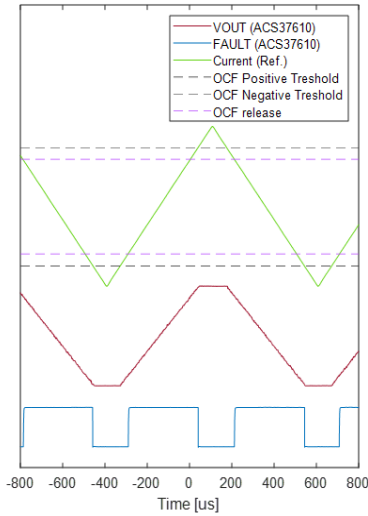

Figure 13: Overcurrent Fault hysteresis $OCF_hyst = 0$

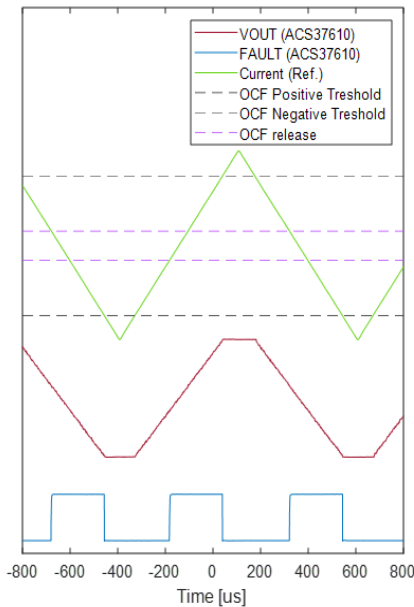

Figure 14: Overcurrent Fault hysteresis $OCF_hyst = 7$

The OCF Hysteresis adjusts the level at which the Fault shall be released and does not influence the overcurrent detection time.

Overcurrent Fault Qualifier

In addition to a programmable hysteresis, the ACS37610 integrates a programmable qualifier delay, which prevent erroneous overcurrent detection due to known current ripples or spikes which should not trigger a Fault.

When used, in order to trigger a Fault, the sensed current must be above the overcurrent threshold for more than the qualifier delay time.

Figure 15 and Figure 16 show examples of Overcurrent Fault response to current ripples with and without qualifier delay.

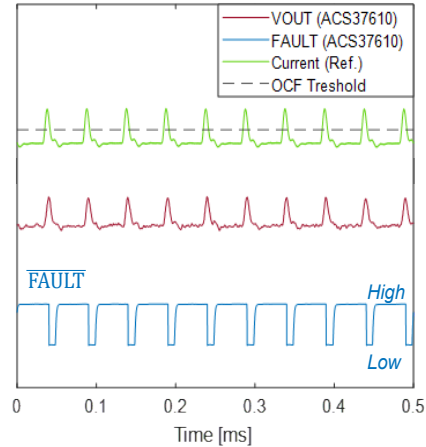

Figure 15: Current ripple, $OCF\ Qualifier = 0$: Current ripple, $OCF\ Qualifier = 2$

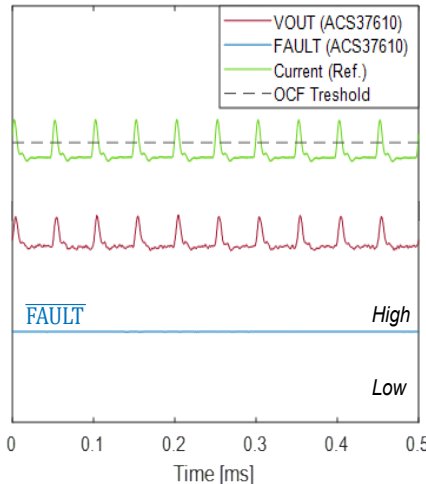

Figure 16: Current ripple, $OCF\ Qualifier = 2$

Figure 16 shows how current ripples or transient can be filtered by the Overcurrent Fault circuit using the qualifier delay to not erroneously trigger the Fault. Nevertheless, the qualifier value to program must be chosen properly since the added delay will also slow down the Overcurrent Fault response time (e.g with " $OCF_Qual = 2$ " OCF response time increases to $4.7\ \mu s$).

Overtemperature Fault

The device integrated temperature sensor can be used to trigger an Overtemperature Fault (OTF), based on a user-programmable

threshold. The OTF threshold can be programmed from 80°C to 165°C typical and includes a fixed (non-programmable) temperature hysteresis of 15°C typical.

Overtemperature Fault will be transmitted in the same way as an Overcurrent event and is complementary to the OCF feature to protect circuit against overheating caused by current overload conditions.

See ACS37610 Datasheet for more details on programming parameters and values.

CONCLUSION

The ACS37610 device not only offers a highly accurate and easy to integrate current measurement solution, but also allows to greatly simplify the design of the overall system thanks to its integrated, fully-programmable overcurrent and overtemperature detection features.

ACS37610 integrated fault features allow :

- Overcurrent detection without compromising accuracy in the operating current range.
- User-programmable thresholds, filtering, and hysteresis parameters for flexible overcurrent detection.
- Micro-seconds reaction time to overcurrent events without the needs for high ADC sampling rate.
- Possibility of information redundancy to reliably detect overcurrent conditions.
- Overtemperature detection to protect against overheating of the sensor due to current overload.

Revision History

Number	Date	Description	Responsibility
-	May 24, 2021	Initial release	Loic Messier

Copyright 2021, Allegro MicroSystems.

The information contained in this document does not constitute any representation, warranty, assurance, guaranty, or inducement by Allegro to the customer with respect to the subject matter of this document. The information being provided does not guarantee that a process based on this information will be reliable, or that Allegro has explored all of the possible failure modes. It is the customer's responsibility to do sufficient qualification testing of the final product to insure that it is reliable and meets all design requirements.

Copies of this document are considered uncontrolled documents.