

CT427-50AC Evaluation Board User Guide

DESCRIPTION

The Allegro MicroSystems CTD427-50AC evaluation board contains the CT427—XtremeSense™ tunnel magnetoresistance (TMR) integrated circuit (IC). This user guide describes the operation and use of the evaluation board as an engineering tool for evaluating the CT427 IC performance in application.

FEATURES

- Integrated current-carrying conductor
- Linear analog output voltage
- Response time: ~300 ns
- Low noise
- Filter function to reduce noise on output pin
- Immunity to common mode fields: -54 dB
- Overcurrent detection
- Supply voltage: 3 V to 3.6 V

EVALUATION BOARD CONTENTS

- CT427-50AC evaluation board

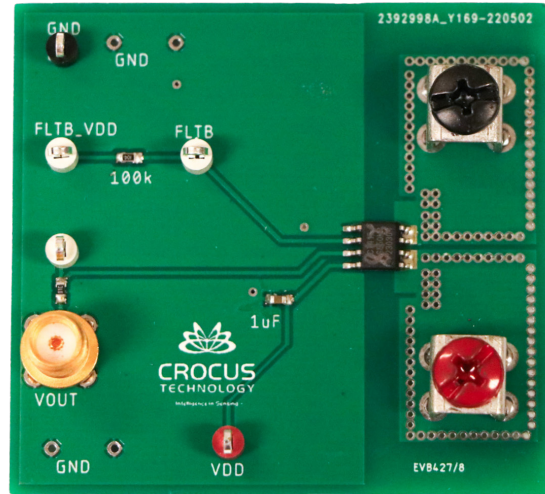

Figure 1: CT427-50AC Evaluation Board

Table of Contents

Description	1
Features	1
Evaluation Board Contents	1
Using the Evaluation Board	2
Introduction	2
Power Input	2
Board Configuration	2
Schematic	3
Layout	4
Bill of Materials	5
Related Links	6
Revision History	7

Table 1: CT427-50AC Evaluation Board Configurations

Configuration Name	Part Number	Sensitivity	Bandwidth
CT427-50AC Evaluation Board	CTD427-HSN850MR	50 mV/V	1 MHz

Table 2: General Specifications

Specification	Min	Nom	Max	Units
Input Operating Temperature	-40	-	125	°C
Input Operating Current	-50	-	50	A

USING THE EVALUATION BOARD

Introduction

The CT427 is a high-bandwidth and ultra-low-noise integrated contact current sensor that uses Allegro-patented XtremeSense™ TMR technology to enable high-accuracy current measurements for many consumer, enterprise, and industrial applications. The device supports eight current ranges where the integrated current-carrying conductor (CCC) handles up to 65 A of current and generates a current measurement as a linear analog output voltage. The device achieves a total output error of less than $\pm 1\%$ full-scale (FS). The device has a 300 ns output response time when the current consumption is ~ 6 mA, and it is immune to common-mode fields. The CT427 has an integrated overcurrent detection (OCD) circuit to identify out-of-range currents (OCD), and the result is output to the fault-bar (FLT) pin. The FLT is an open-drain, active-low digital signal that is activated by the CT427 to alert the microcontroller that a fault condition has occurred. The CT427 is offered in an industry-standard 8-lead small-outline integrated circuit (SOIC) package that is green and Restriction of Hazardous Substances (RoHS) compliant.

This section provides an overview of the connections and configuration options of the CT427 evaluation board. The proper configuration is highlighted and detailed in Figure 2. The CT427 datasheet contains detailed information about the use and functionality of each pin and detailed specifications about the sensor. For more detailed information, refer to the product datasheet.

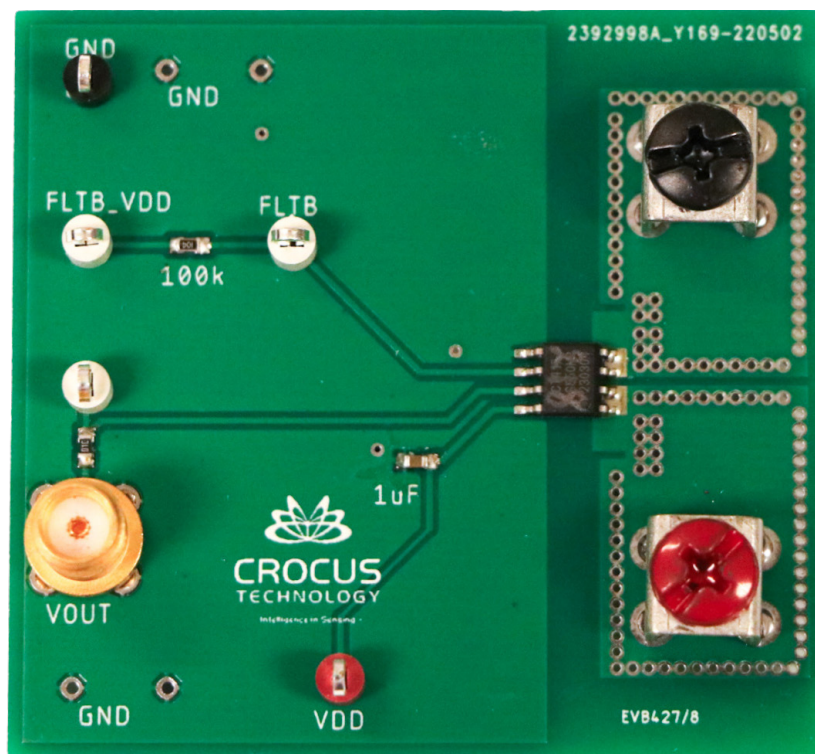

Figure 2: CT427-50AC Evaluation Board

Power Input

The two large connectors (with screws) are used to connect and drive the external current to be measured. Due to the PCB trace thermal limitation of the CT427 evaluation board, do not exceed 50 A_{PK}.

Board Configuration

A fully assembled evaluation board is illustrated in Figure 1 and Figure 2. The current to be measured is connected to the screw connectors located on the right side of the PCB. These connectors are galvanically isolated from the rest of the PCB. The CT427 can be biased by applying a 3.3 V bias voltage between the VDD and GND pins on the PCB and its output can be measured either from the VOUT SMA connector or the VOUT header pin on the PCB.

SCHEMATIC

The schematic of the CT427-50AC evaluation board is shown in Figure 3.

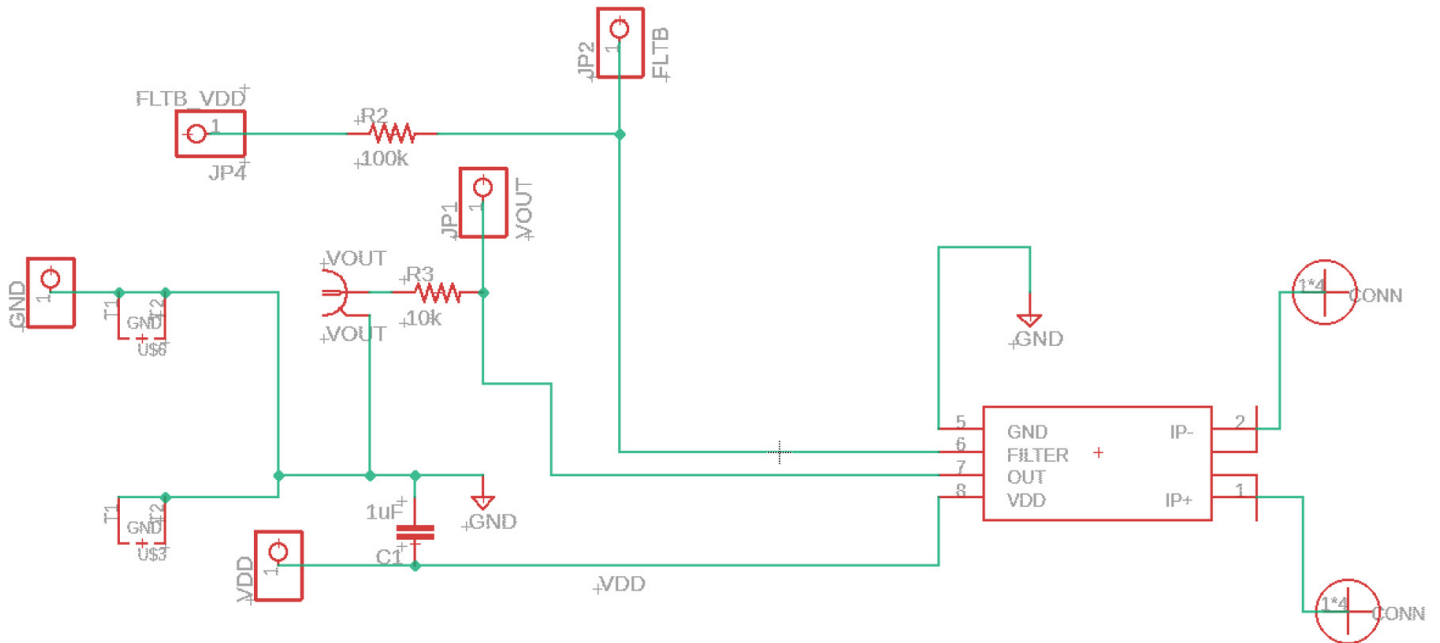

Figure 3: CT427-50AC Evaluation Board Schematic

LAYOUT

The top and bottom layers of the CT427-50AC evaluation board are shown in Figure 4 and Figure 5, respectively.

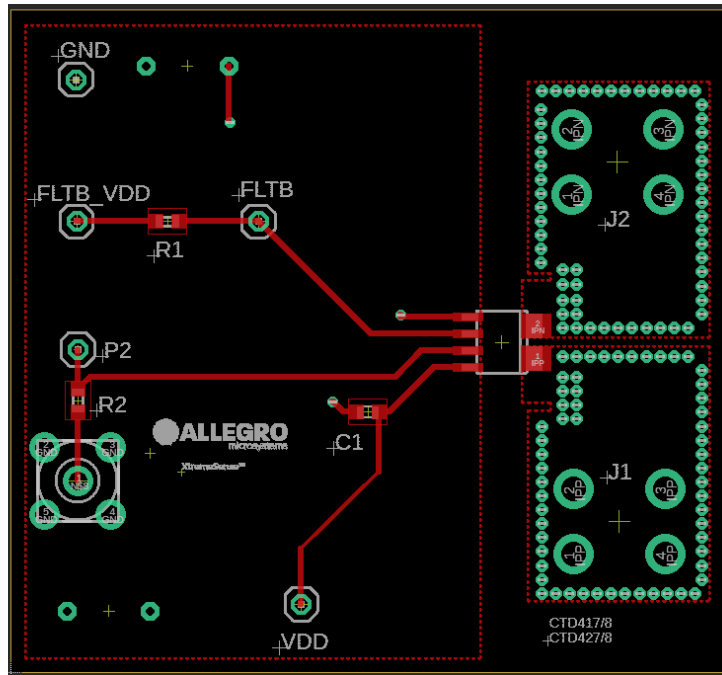

Figure 4: Top Layer

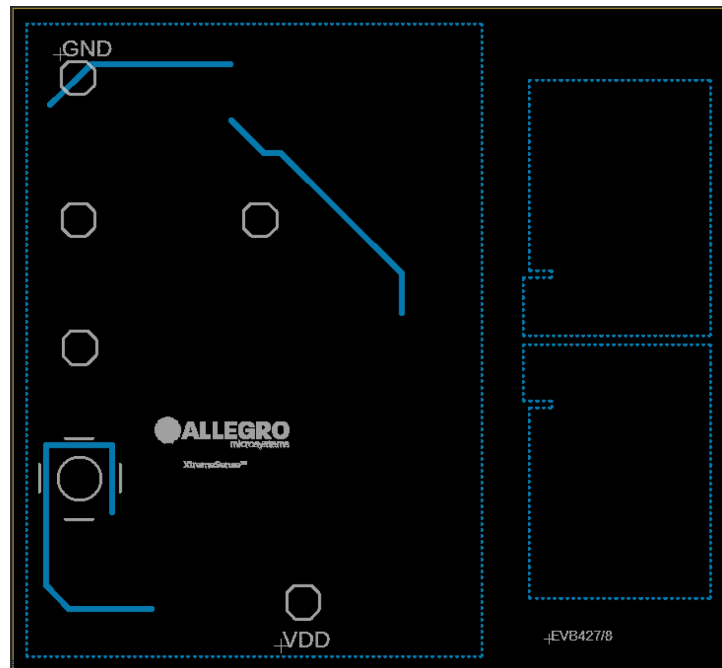

Figure 5: Bottom Layer

BILL OF MATERIALS

Designator	Quantity	Description	Manufacturer	Manufacturer Part Number
PCB	1	CT427-50AC evaluation board	Allegro MicroSystems	–
U1	1	CT427 sensor	Allegro MicroSystems	–
C1	1	1.0 μ F, X5R or better SMD Capacitor 0603	TDK	CGA3E1X7R1E105K080AC
R2	1	10 k Ω , \pm 10% or better SMD Resistor 0603	Panasonic, AVX, Yageo	ERJ-3GEYJ103V
R1	1	100 k Ω , \pm 10% or better SMD Resistor 0603	Yageo	RC0603FR-07100KL
Vout	1	SMA Connector	Clinch Connectivity	142-0701-201
J1, J2	2	Screw Connectors	Keystone, Blockmaster	534-7701
J2	1	M3 Terminal Screw Red	Keystone	36-7701-2
J1	1	M3 Terminal Screw Black	Keystone	36-7701-3
GND, FLTB_ VDD, FLTB_ VDD, P2	5	Male Header Connectors - Single pin	Würth Elektronik	732-5334-ND

RELATED LINKS

CT427 product page:

<https://www.allegromicro.com/en/products/sense/current-sensor-ics/zero-to-fifty-amp-integrated-conductor-sensor-ics/ct425-6-7-8>

For samples or applications support contact, visit <https://www.allegromicro.com/en/about-allegro/contact-us/technical-assistance> and navigate to the appropriate region.

Revision History

Number	Date	Description
-	August 7, 2024	Initial release

Copyright 2024, Allegro MicroSystems.

Allegro MicroSystems reserves the right to make, from time to time, such departures from the detail specifications as may be required to permit improvements in the performance, reliability, or manufacturability of its products. Before placing an order, the user is cautioned to verify that the information being relied upon is current.

Allegro's products are not to be used in any devices or systems, including but not limited to life support devices or systems, in which a failure of Allegro's product can reasonably be expected to cause bodily harm.

The information included herein is believed to be accurate and reliable. However, Allegro MicroSystems assumes no responsibility for its use; nor for any infringement of patents or other rights of third parties which may result from its use.

Copies of this document are considered uncontrolled documents.